

# INSTRUCTION MANUAL

SKU CODE:  
DEC077A-G

FRONT

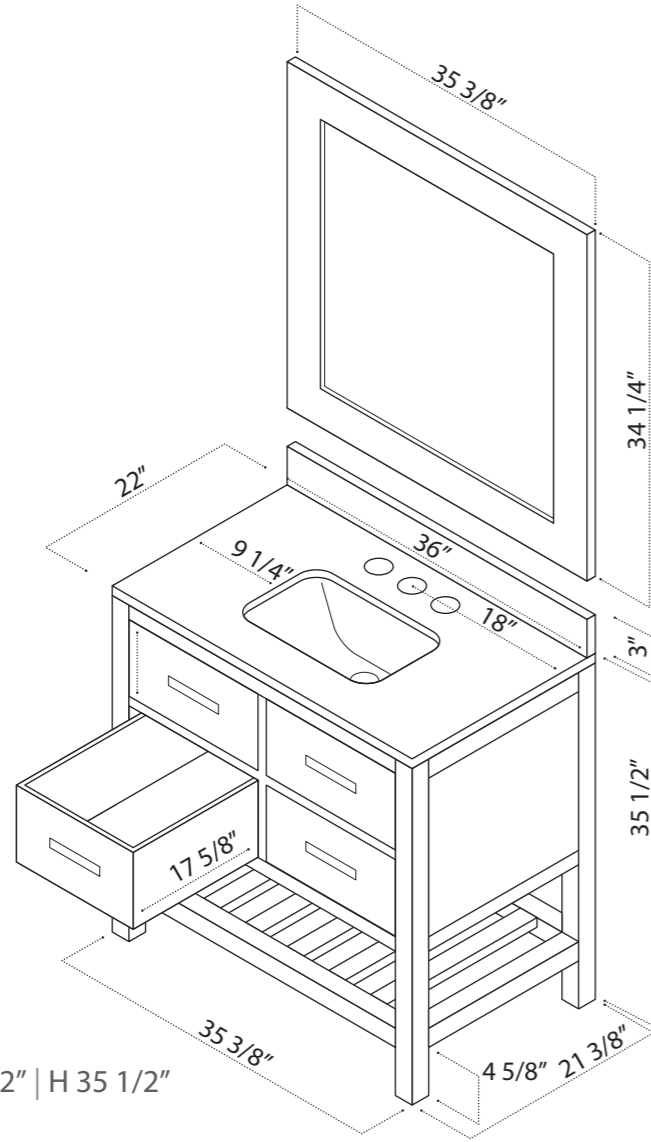

COLLECTION: London  
SERIES: Cambridge

DIMENSIONS: W 36" | D 22" | H 35 1/2"

BACK

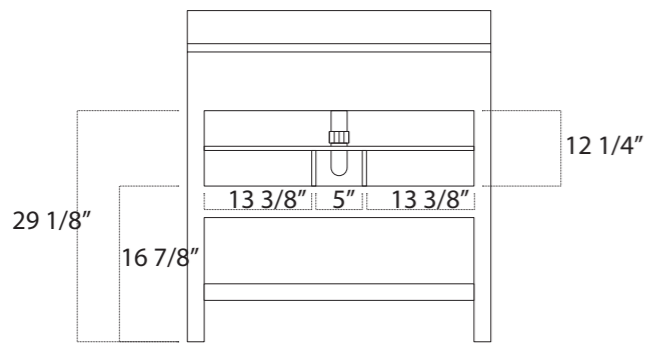

## Attaching Sink To The Counter Top

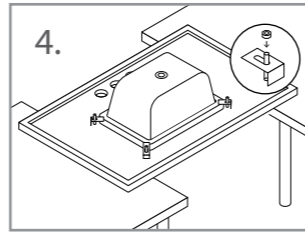
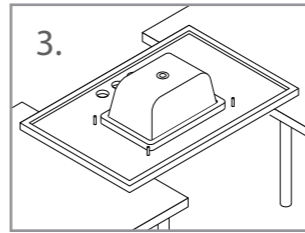
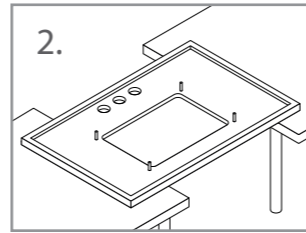
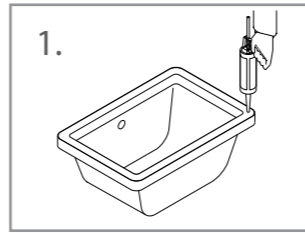

1. Apply continuous stream of silicon glue on circumference
2. Turn the counter top upside down and provide support from beneath.  
(Note: While turning around the double sink counter tops,
3. Put the glued sink over the cutout and attach it firmly.
4. Tie up screws positioned at the respective places on the

## Attaching Counter Top To Cabinet

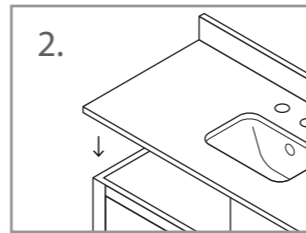
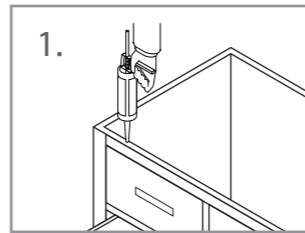

1. Apply continuous stream of quality silicon glue to the top of the cabinet where the countertop needs to be
2. Place the countertop on the glued cabinet.
3. Don't start using the vanity right away. Wait for approximately 24 hours so

## Installing The Drain On The Sink

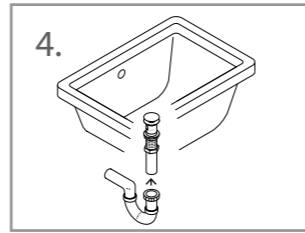
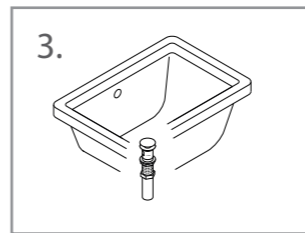
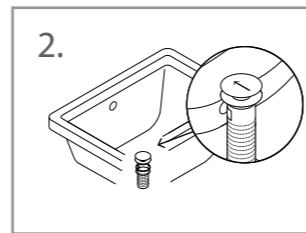
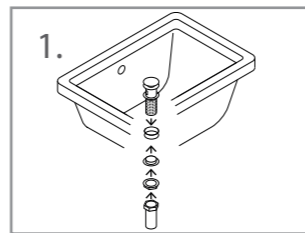

1. After installing the counter top on the cabinet, put the drain assembly inside the hole in the sink and fix it firmly.
2. For the overflow sinks, make sure that the overflow hole on the drain is aligned straight in the direction of the
3. Tie up the mounting rubbers and metal rings from the bottom of the drain onto the drain bottom.

## Hanging Mirror On The Wall

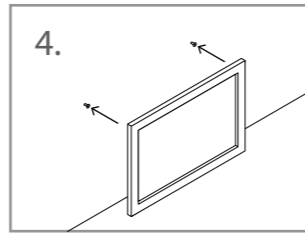
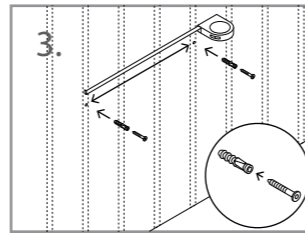
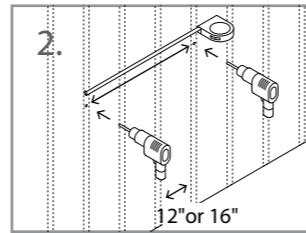
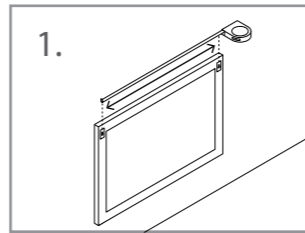

1. Measure the distance between the screw holes from the
2. Locate the studs on the wall. They are normally placed 12" to 16" apart from each other. Drill two holes on the studs as
3. Insert the plastic plugs into the drilled holes and then insert screws into the plastic plugs. Tie up the screws till they
4. Hang the mirror on to the screws.

## SAFETY AND PRECAUTIONS

- Please go through this entire instruction manual before making any attempt to assemble, operate or install the product.
- During installation, handle the countertop and sink with optimum care. They might break if hit hard on a solid surface.
- Don't start using the vanity right away. Wait for approximately 24 hours after installation so that the silicon glue can dry.
- When scrubbing the cabinet while cleaning, make sure you do not remove or scratch the finish.

## CARE AND CLEANING

- Avoid using any type of rough cleaning material on top of the cabinet finish.
- Use mild liquid soap and water-dampened soft cloth to remove stains from the cabinet and to clean the marble countertop.
- For the glass part of the mirror, use ammonia-free cleaning products.

## CONTACT SUPPORT

PHONE: (888) 487-4488  
EMAIL: [cs@designelementusa.com](mailto:cs@designelementusa.com)  
ADDRESS: 8715 Boston place, Rancho Cucamonga, CA. 91730

[www.designelementusa.com](http://www.designelementusa.com)



## PACKING LIST

- Pre-assembled cabinet
- Countertop
- 1 Sink
- 1 Mirror
- Mirror mounting screws
- Drain
- Instruction Manual

## WARRANTY

Design Element warrants cabinets, mirrors, finishes and fittings to be free from defects in workmanship and materials under normal use and service for a period of one (1) year.  
Please report any damage or missing pieces of your vanity to us immediately. These things must be reported no later than 30 days from the date of delivery.