

INSTRUCTION MANUAL

SKU CODE:
DEC072A

FRONT

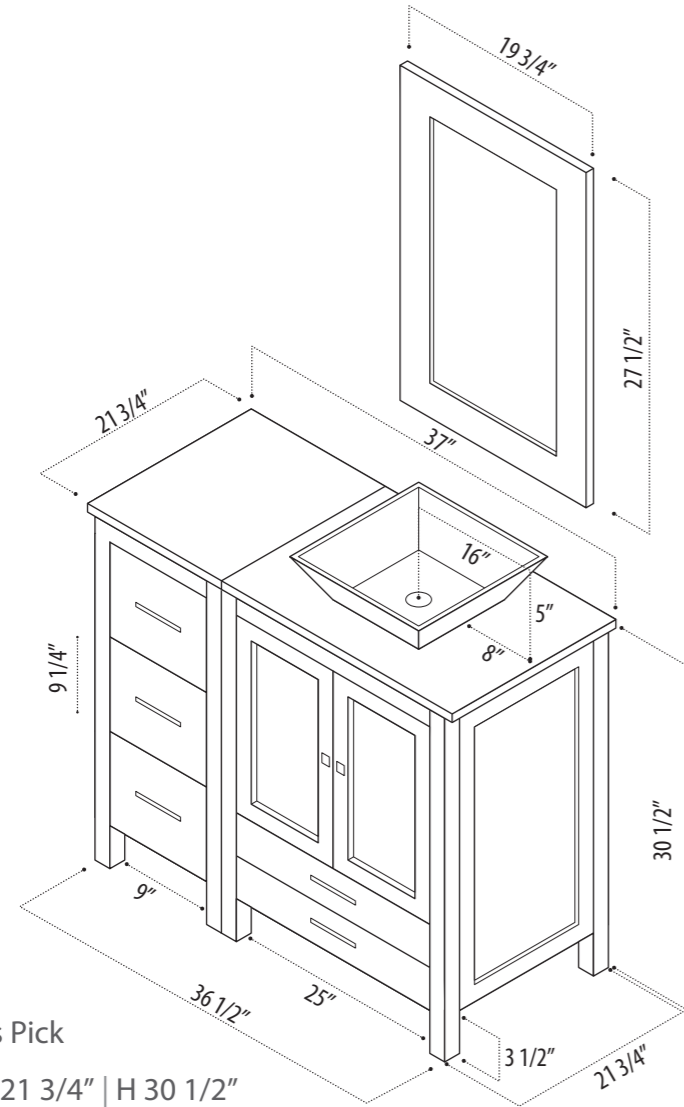
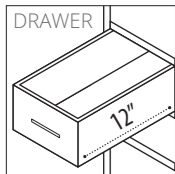

COLLECTION: Designer's Pick

DIMENSIONS: W 37" | D 21 3/4" | H 30 1/2"

BACK

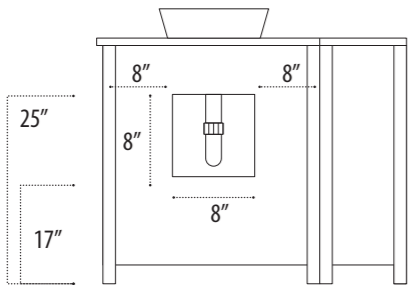

PACKING LIST

- Pre-assembled cabinet
- Countertop
- 1 Sink
- 1 Mirror
- Mirror mounting screws
- Drain
- 1 side cabinet
- Instruction Manual

WARRANTY

Design Element warrants cabinets, mirrors, finishes and fittings to be free from defects in workmanship and materials under normal use and service for a period of one (1) year. Please report any damage or missing pieces of your vanity to us immediately. These things must be reported no later than 30 days from the date of delivery.

Attaching Counter Top To Cabinet

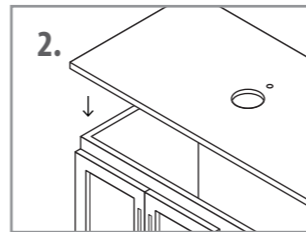
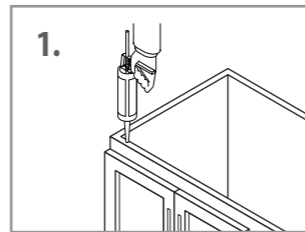

1. Apply continuous stream of quality silicon glue to the top of the cabinet where the integrated sink needs to be placed.
2. Place the integrated glass sink on the glued cabinet.

Attaching Sink To Counter Top

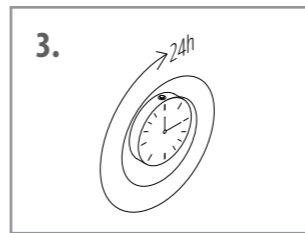
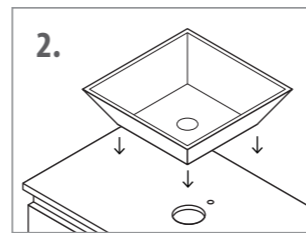
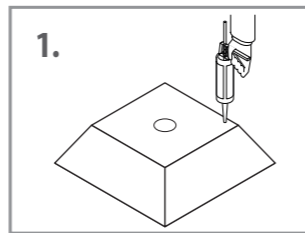

1. Add silicon glue to the porcelain vessel sink.
2. Position and place the vessel sink in a way that it fits in the cut out area on the countertop.
3. Do not use the sink instantly. Wait approximately for 24 hours for the Silicon glue to dry.

Installing The Drain On The Sink

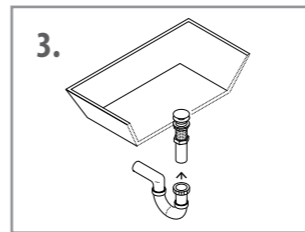
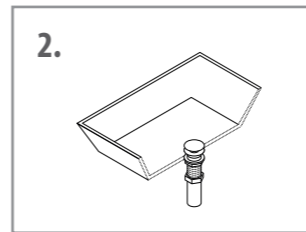
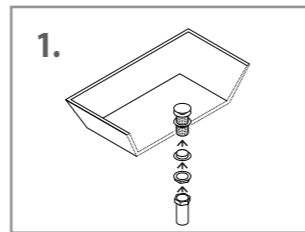

1. After you install the sink on the counter top, Put the drain assembly inside the hole in the sink and fix it firmly
2. Tie up the mounting rubbers and rings from the bottom of the drain
3. Connect the trap onto the drain bottom.

Hanging Mirror On The Wall

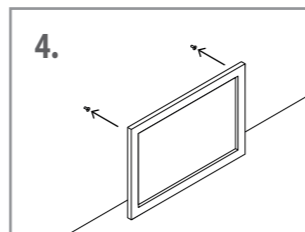
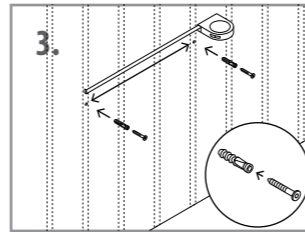
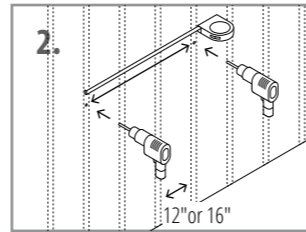
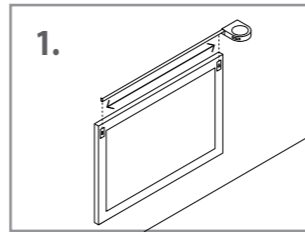

1. Measure the distance between the screw holes from the back of the mirror.
2. Find the studs on the wall. They are normally 12" to 16" apart from each other. Drill two holes on the studs as per your measurement.
3. Insert the plastic plugs into the drilled holes. Insert screws into the plastic plugs. Leave the screws at least 0.5" – 0.75" inches outside.
4. Hang the mirror on to the screws.

SAFETY AND PRECAUTIONS

- Please go through this entire manual before attempting to assemble, operate or install the product.
- During installation, handle the countertop and sink with optimum care.
- Do not use the vanity instantly after installation. Once you have applied glue to attach the countertop and sink, wait for approximately 24 hours to let it dry.
- Avoid extreme hot then cold water on the glass sinks and countertops, as it might damage it.
- When scrubbing the cabinet, make sure you do not remove or scratch the Finish.

CARE AND CLEANING

- Avoid using any type of rough cleaning material on top of the cabinet Finish.
- Use mild liquid soap and water-dampened soft cloth to remove stains from the cabinet and to clean the countertop.
- For the glass part of the mirror, use ammonia-free cleaning products.

CONTACT SUPPORT

PHONE: (888) 487-4488
EMAIL: cs@designelementusa.com
ADDRESS: 8715 Boston place, Rancho Cucamonga, CA. 91730

www.designelementusa.com

